

Instruction Manual

BL7916 • BL7917

pH and ORP Measuring & Dosing System

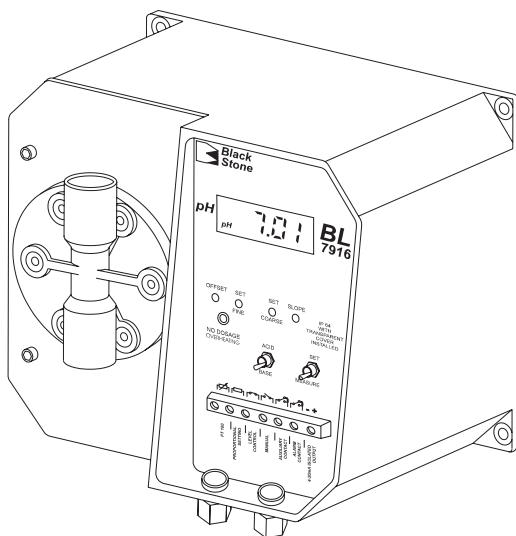

 **HANNA**[®]
instruments

www.hannainst.com

Dear Customer,

Thank you for choosing a Hanna Instruments Product.

Please read this instruction manual carefully before using the pump.

If you need additional technical information, do not hesitate to e-mail us at tech@hannainst.com.

These instruments are in compliance with the **CE** directives.

WARRANTY

All Hanna Instruments **pumps are warranted for one year** against defects in workmanship and materials when used for their intended purpose and maintained according to instructions. This warranty is limited to repair or replacement free of charge. Damages due to accident, misuse, tampering or lack of prescribed maintenance are not covered. If service is required, contact your local Hanna Instruments Office. If under warranty, report the model number, date of purchase, serial number and the nature of the failure. If the repair is not covered by the warranty, you will be notified of the charges incurred. If the instrument is to be returned to Hanna Instruments, first obtain a Returned Goods Authorization Number from the Customer Service department and then send it with shipment costs prepaid. When shipping any instrument, make sure it is properly packaged for complete protection.

TABLE OF CONTENTS

PRELIMINARY EXAMINATION	3
GENERAL DESCRIPTION	4
FLOW RATE CHART	5
FUNCTIONAL DESCRIPTION BL7916.....	6
FUNCTIONAL DESCRIPTION BL7917	7
SPECIFICATIONS	8
VALVE / HOSE ASSEMBLY DIAGRAM	9
MECHANICAL DIMENSIONS	10
INSTALLATION	11
OPERATIONAL GUIDE	18
pH CALIBRATION	22
TROUBLESHOOTING GUIDE	23
MAINTENANCE	24
ELECTRODE CONDITIONING AND MAINTENANCE.....	26
TAKING REDOX MEASUREMENTS	30
CHEMICAL COMPATIBILITY GUIDE.....	32
ACCESSORIES	34
CE DECLARATION OF CONFORMITY.....	39

PRELIMINARY EXAMINATION

Remove the pump from the packing material and examine it carefully to make sure that no damage has occurred during shipping. If there is any noticeable damage, please contact your local Hanna Instruments Office.

Each pump is supplied complete with:

- discharge and suction valves
- LDPE tubing, 7 m (23')
- power cord
- instruction manual

Note: Save all packing material until you are sure that the pump functions correctly. Any defective item must be returned in the original packaging together with the supplied accessories.

READ THE INSTRUCTIONS ATTENTIVELY BEFORE INSTALLING OR OPERATING YOUR PUMP

The BL electronic dosing pumps are easy to use. We recommend, however, that you read the entire manual before using the pump. Familiarity with the features and controls of the unit will give you a better idea of the dosing potential and help reduce operator errors. Please operate the pump only as directed in the instruction manual. Follow all general safety guidelines during operation.

Remember: electrical devices are potentially hazardous. Check that the voltage of the installation matches the voltage indicated on the specification label on the back of the pump.

Note: It is the responsibility of the user to install and ground the pump properly; it is highly recommended to install an external switch.

Each pump is protected by a 1 A/250 V fuse that is located together with 1 spare in a drawer on the power socket under the pump.

Always store chemicals in safe, out of reach places. Follow the directions for use with each chemical. Do not assume chemicals are the same because they look alike. Hanna Instruments cannot be held responsible for the misuse of chemicals or the pump.

Always wear protective clothing (gloves and safety glasses) when working near chemical dosing pumps. When pumping chemicals, make sure all tubes are securely attached to the fittings. It is recommended that tubing is shielded to prevent possible injury in case of rupture or accidental damage.

Avoid using a pipe wrench or pliers on plastic parts and connectors.

These are best tightened with an open end or crescent wrench. Avoid overtightening these parts as this could cause damage to the seats and threads.

If a hose is used, it should be securely fastened to columns, walls, braces, etc. This will ensure that the hose connection will remain tight and leak free. Shield the hose from direct sunlight. Sunlight can cause an autocatalytic reaction with some chemicals and weaken the hose walls.

The arrow on the pump head indicates the direction of chemical flow and should always point upwards (vertically). Never position the pump horizontally with suction and discharge valves horizontal. Locate the pump in an area out of the reach of children and pets.

All pumps undergo stringent tests to ensure that they comply with their stated specifications and are calibrated at the maximum rated pressure.



Unplug the instrument from the power supply before replacing the fuse or making any electrical connections.

GENERAL DESCRIPTION

The BL7916 and BL7917 Control/Pump System offer respectively a pH and ORP monitoring system with proportional control of a diaphragm pump and an LCD readout.

Features include:

- Two advanced instruments in one compact unit
- Proportional control for precisely maintained set-points
- Rugged construction with a one-piece casing and a transparent cover to protect controls and terminals
- Chemically resistant non-clogging pump head and superior materials for all components in contact with the chemicals being dosed (see page 32 for details)
- Convenient installation with all controls on front panel
- A solenoid-driven pump
- Automatic overheat protection and a built-in LCD display
- Alarm output: the alarm of the BL7916 will be activated if the measured pH value is 2 pH units higher or lower than the setpoint. BL7917's alarm will activate if the mV value is 200mV higher or lower than the setpoint.
- Auxiliary dosing contacts. This will drive other equipment such as mixers, priming pumps, etc.

FLOW RATE CHART

The following chart shows the inverse relationship between flow rate and pressure.

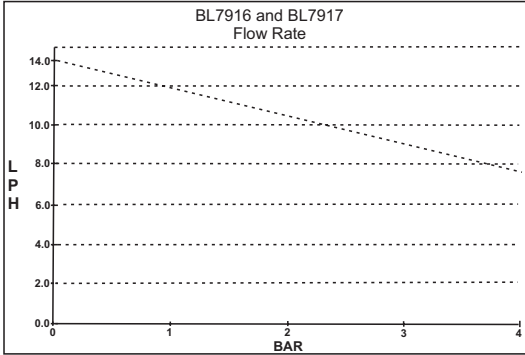

The table below shows typical reduction of the flow rate with an increase of pressure. The pump supplied with the system has a capacity of 13.3 LPH (3.5 GPH) at 0.5 BAR (7.4 PSI).

BL7916 / BL7917 FLOW / PRESSURE	
BAR (PSI)	LPH (GPH)
0.5 (7.4)	13.3 (3.46)
1.0 (14.7)	11.7 (3.04)
2.0 (29.4)	10.1 (2.63)
3.0 (44.1)	9.0 (2.33)
4.0 (58.8)	7.88 (2.03)

FUNCTIONAL DESCRIPTION BL7916

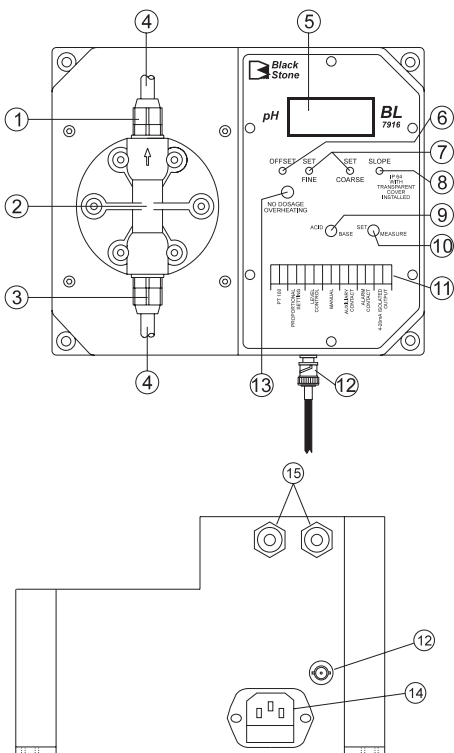

1. Discharge Valve Assembly
2. Pump head
3. Suction Valve Assembly
4. Hose
5. Liquid Crystal Display
6. Offset Calibration Trimmer
7. Setpoint Adjustment Trimmers (FINE and COARSE)
8. Slope Calibration Trimmer
9. Acid/Base Selection Switch
10. Display Mode Selection Switch (SET or MEASURE)
11. Terminal Connections
12. BNC Connector for pH electrode
13. Overheating LED
14. Power Socket and Fuse Holder
15. Cable Glands



Unplug the instrument from the power supply before replacing the fuse or making any electrical connections.

FUNCTIONAL DESCRIPTION BL7917

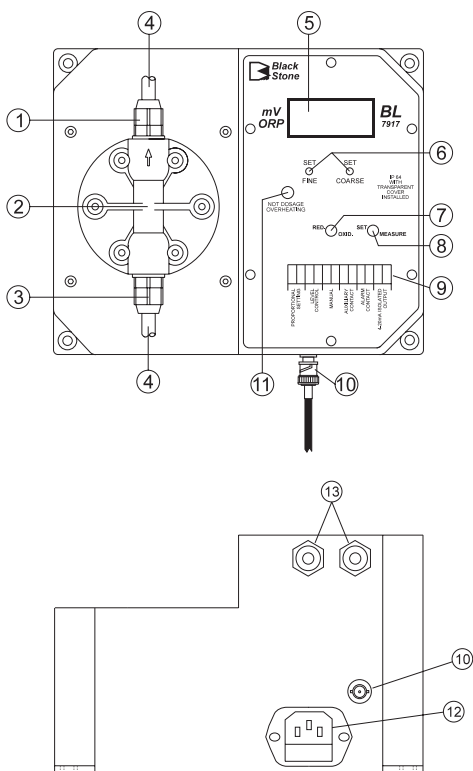

1. Discharge Valve Assembly
2. Pump head
3. Suction Valve Assembly
4. Hose
5. Liquid Crystal Display
6. Setpoint Adjustment Trimmers (FINE and COARSE)
7. Reduction/Oxidation Selection Switch
8. Operating Mode Selection Switch (SET or MEASURE)
9. Terminal Connections
10. BNC Connector for ORP electrode
11. Overheating LED
12. Power Socket and Fuse Holder
13. Cable Glands



Unplug the instrument from the power supply before replacing the fuse or making any electrical connections.

SPECIFICATIONS

	BL7916D	BL7916U
Range	0.00 to 14.00 pH	
Resolution	0.01 pH	
Accuracy (@25 °C/77 °F)	±0.01 pH	
Typical EMC Deviation	±0.1 pH	
Input Impedance	10 ¹² Ohm	
Dosage	Proportional, acid or base, user selectable	
Dosing Contact	Isolated, 2A, Max. 240V, resistive load, 1,000,000 strokes	
Alarm Contact	Isolated, 2A, Max. 240V, resistive load, 1,000,000 strokes	
Calibration	Offset: ±1 pH with trimmer Slope: 85 to 115% with trimmer	
Recorder Output	4 to 20 mA (isolated)	
Power Supply	230 Vac ±15% 50/60 Hz (40 W)	115 Vac ±15% 50/60 Hz (40 W)
Environment	0 to 50 °C (32 to 122 °F); RH max 95% non-condensing	
Dimensions	221 x 142 x 181 mm (8.7 x 5.6 x 7.1")	
Weight	Approximately 5 kg (11 lb.)	

	BL7917D	BL7917U
Range	-999 to +999 mV	
Resolution	1 mV	
Accuracy (@25 °C/77 °F)	±5 mV	
Typical EMC Deviation	±6 mV	
Input Impedance	10 ¹² Ohm	
Dosage	Proportional, oxidizing or reducing, user selectable	
Dosing Contact	Isolated, 2A, Max. 240V, resistive load, 1,000,000 strokes	
Alarm Contact	Isolated, 2A, Max. 240V, resistive load, 1,000,000 strokes	
Recorder Output	4 to 20 mA (isolated)	
Power Supply	230 Vac ±15% 50/60 Hz (40 W)	115 Vac ±15% 50/60 Hz (40 W)
Environment	0 to 50 °C (32 to 122 °F); RH max 95% non-condensing	
Dimensions	221 x 142 x 181 mm (8.7 x 5.6 x 7.1")	
Weight	Approximately 5 kg (11 lb.)	

VALVE / HOSE ASSEMBLY DIAGRAM

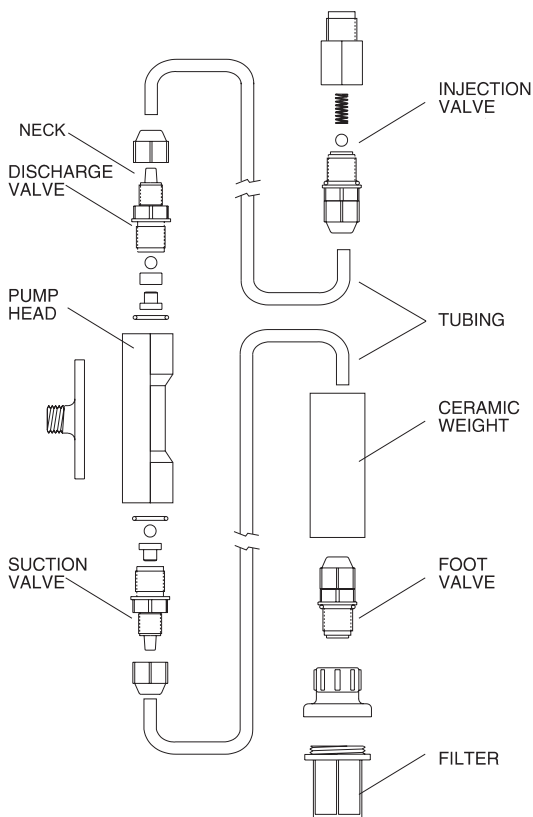

MECHANICAL DIMENSIONS

The Controller/Pump series of instruments are enclosed in a modular housing for maximum protection. The dimensioned illustrations show the layout of the Controller/Pumps and how they utilize the one-piece polypropylene, injection-molded housing. Since there are no joints or screws holding different sections of the housing together, the case is extremely rugged and sturdy.

BOTTOM VIEW

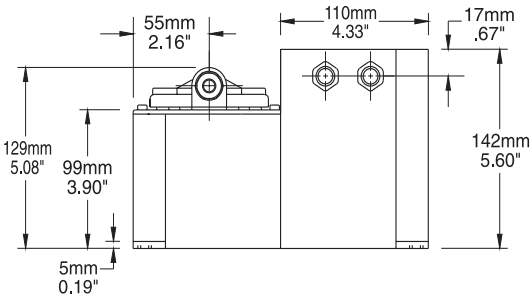

FRONT VIEW

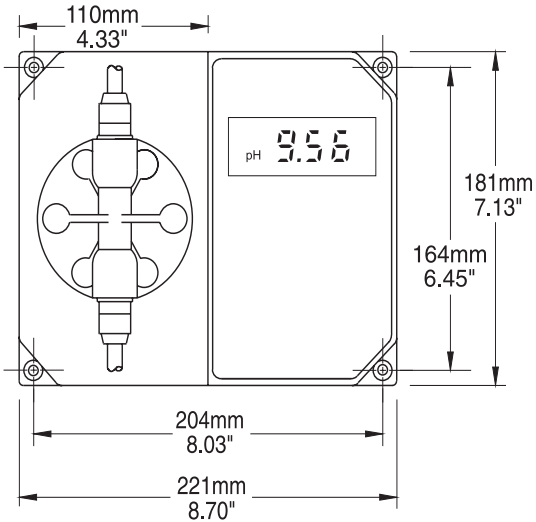

INSTALLATION

Materials Needed

- LDPE hose (7 meter/22 feet) (**included**) or other type of tubing (PTFE, for example) more suitable for a specific application (optional)
- Power cord (**included**)

Optional Accessories

- 4 each, ceramic weights (**HI721008**)



- 1 each, foot valve assembly (**HI721005**)

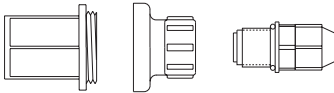

- 1 each, injection valve assembly (**HI721004**)



Location

A suitable location should:

- be near to a power source
- be conveniently close to the injection point
- allow easy access to the flow rate control and pipe or hose connections
- be no more than 1.5 meters (5 feet) above the operating position of the suction valve assembly.

Dimensions for Installation

BlackStone Pumps are designed for permanent installation.

The pump can be mounted directly on a wall or tank (see page 10 for the specific mounting dimensions).

Power Requirements

BlackStone pumps are designed to operate to specifications within the following voltage ranges:

100 - 130 Volts for 115 Vac models

200 - 250 Volts for 230 Vac models

To ensure maximum performance, check the voltage at the point of supply to verify that it is sufficient. It is recommended that you install a 1 Amp circuit breaker between the pump and the power supply. This will give additional protection to the internal circuit and provide a convenient way to disconnect the power supply prior to servicing the pump, if needed.

Injection Point

- Choose an injection point that allows you to mount the injection valve assembly vertically.
- The spring in the injection valve assembly (**HI721004**) adds approximately 1.5 bar of back pressure. If pumping into a high back pressure, the spring should be removed.

Other Considerations

- If you are mounting the system to a wall, column, etc., be sure it is strong enough to support the weight of the entire system.
- The ambient temperature of the pump, when in operation, should be between 0 and 50 °C (32 to 122 °F) and should be protected from direct exposure to outdoor elements (direct sunlight, rain, extreme temperatures, high humidity, etc.).
- Generally speaking, the shorter the suction distance, the more efficient the pump operates.
- The pump should be placed in a conventional location that will allow easy access to the control and connections. It should be placed so that regular visual inspections of the connections and hoses are facilitated.

Vertical Surface Mounting

Once you have selected the best installation site, simply screw or bolt the unit into a wall or mounting panel above the chemical feed tank. The 4 mounting screw holes on the pump will accommodate up to a 5 mm (3/16") screw or bolt (remember to use heavy screws or bolts to secure the system). Be sure you do not over tighten and cause excessive stress on the mounting holes.

Make sure to leave a slight overhang in front to allow for the connection cable.

Power Supply

Connect the power cord to the female socket of the pump and by doing so also grounding it. The power socket contains a 1 A/250 V fuse. Since there is no on/off switch, it is suggested to install an outside switch.

Probe connections

Connect the pH/ORP electrode to the BNC socket of the pump.

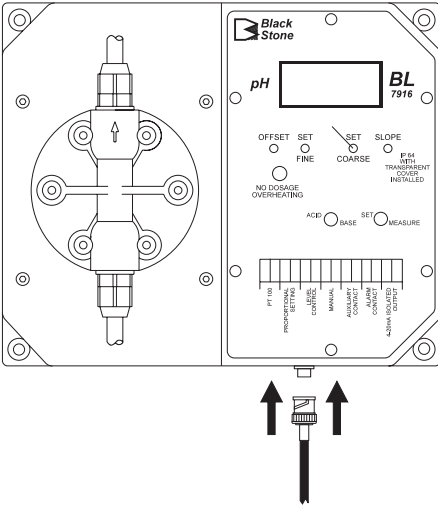

Permanent Connection using 3/8" PVC pipe

All piping for the pump feed and discharge should be plumbed to the location of the pump.

The threads on both valve assemblies allow the use of standard 3/8" (European) pipe fittings for permanent pipe connections.

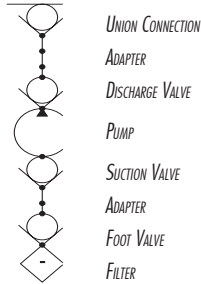
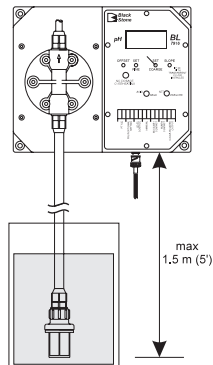

Diagram for Rigid Pipe Hose

The foot valve assembly (H1721005) should always hang vertically and not lay horizontal on the bottom of the tank or drum.

A vertical assembly will ensure that the valve is positioned properly and prevent loss of prime.

For the US standard installations, use PVC adapters to connect the suction and discharge valves to the PVC pipe.



Hose Connections

- Cut a long enough section of the hose to reach the suction valve of the pump head from the feed tank. Allow some slack in the hose and be sure it is not kinked or twisted.
- Slip a hose connector onto the hose over the head valve and up to the bottom of the threads ensuring it is fully seated.
- Slide the connector up to the threads and tighten to form a seal.

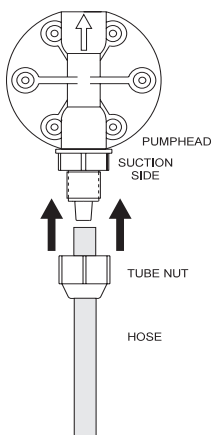
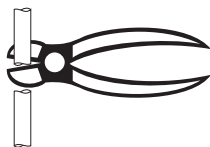
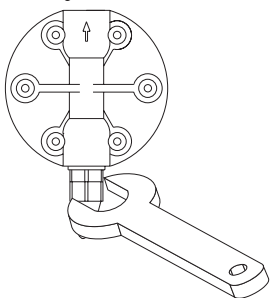

- Slip the ceramic weight (HI721008) and a connector over the other end of the hose.

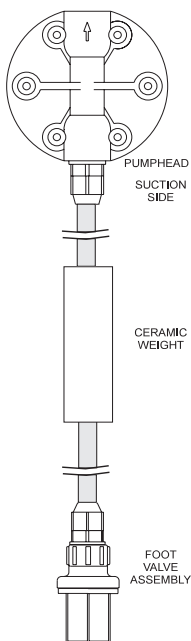

- Attach the foot valve assembly (HI721005) to the hose and slide the connector up to the threads and tighten to form a seal.

- Repeat the same installation procedure for the hose connections on the discharge end with the injection assembly (HI721004)

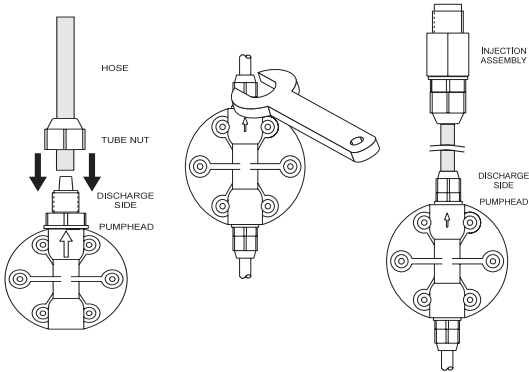

- Secure the hose so that its movement is minimized when the pump is operating. Excessive hose movement could cause the connectors to loosen and result in leakage.

Assembling the Hose to the Valve

The end of the valve is specially tapered to form a leak free seal when the hose is properly installed.

Be sure to seat the hose completely so that there is no gap. Push the hose until it covers the end of the valve completely.

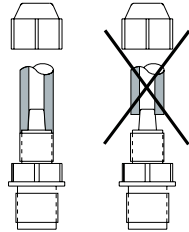

Suction and Discharge Valves

The suction and discharge valves located on the pump head should not be interchanged as they are different internally. The discharge valve is fitted with a valve guide and will not function properly if used on the suction side.

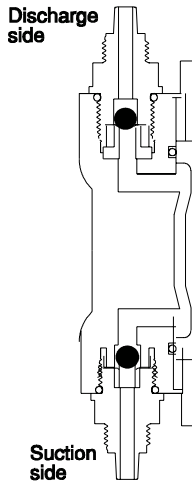

EXAMPLE OF TYPICAL INSTALLATIONS

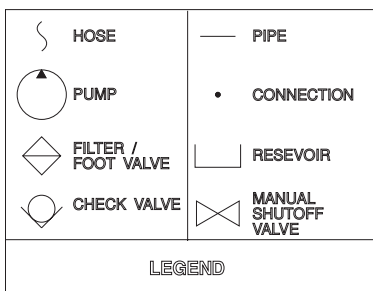

Flooded Suction Installation

Suggested Installation for consistent output when using a low stroke rate. Also suggested for highly viscous chemicals.

A slight suction pressure avoids self-priming problems, especially with high viscosity liquids.

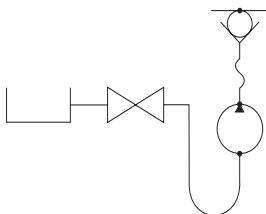

Suction Lift Installation

Suggested installation for most in-line applications with nominal output and pressures.

The maximum self-priming height is 1.5 m (5 ft.). It is advisable to install a level controller in order to stop the pump when feed tank (reservoir) liquid level is low.

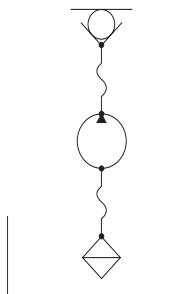

Uphill Installation

Suggested installation whenever the supply is located higher than the discharge point; typically a waste water application.

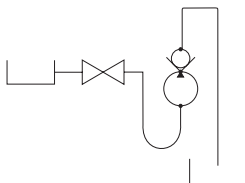

It is important to install the Injection valve to prevent siphoning.

Downhill Installation

Suggested installation when pumping from one container to another, each at different levels and with only nominal pressure.

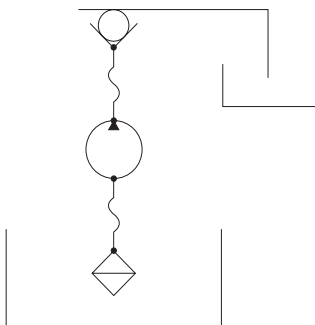

START-UP

At start-up, purge all chemical gases and air from the suction tubing, valves and pump head. Start the pump.

When all the air or gas is vented, the solution being metered will appear in the output line.

Note: Only when operating under pressure, the pump must be started unloaded.

OPERATIONAL GUIDE

- Unscrew and remove the transparent front panel cover and gasket seal for access to the terminals.

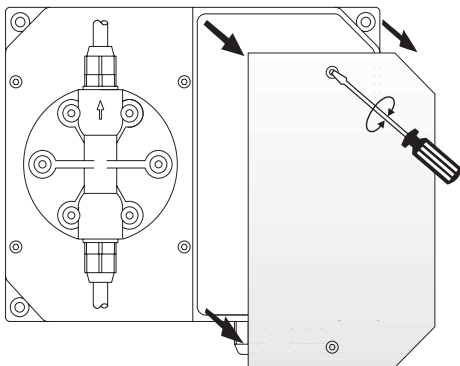

- Remove the protective plastic plate covering the terminals by removing the 2 screws on both sides of the plate.

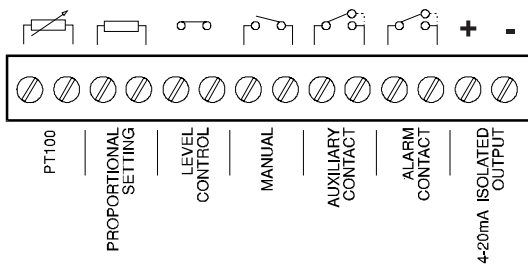
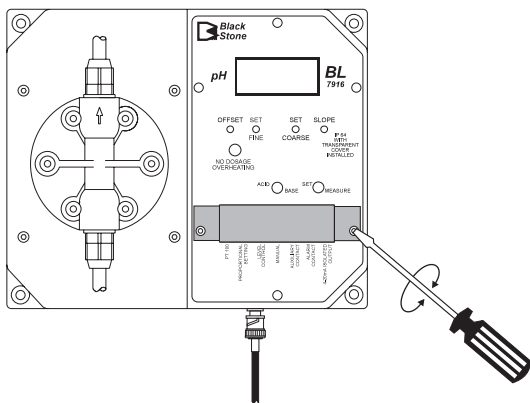

TERMINAL CONNECTIONS BL7916

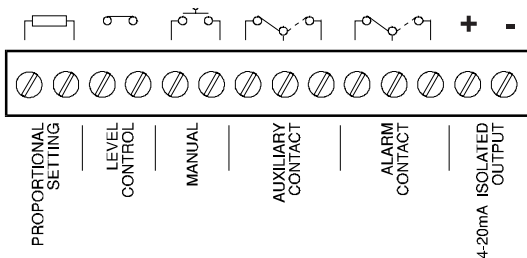

TERMINAL CONNECTIONS BL7917

Pt100 (for BL7916 only)

A 2-wire Pt100 can be connected to provide automatic temperature compensation of the pH measurements. The pump is supplied with a 110 Ohm resistor connected to the 2 Pt100 terminals. This delivers a fixed temperature compensation of 25 °C (77 °F). The Pt100 is recommended only in special instances where very high accuracy is absolutely necessary since the error is only 0.03 pH for a temperature difference of 10 °C in the pH6 to 8 range. The error will consequently be less than 0.09 pH at readings from pH4 to 10 when the temperature is in the 15 °C (59 °F) to 35 °C (95 °F) range.

PROPORTIONAL SETTING

The pump is supplied with a 10K resistor connected to these terminals. With this value the pump works at 100% of the rating when the difference between measure and setpoint is more than 150 mV (**BL7917**) or 1.5 pH (**BL7916**). It goes into proportional dosing for values less than the above.

You can vary this hysteresis band by simply changing the resistor as follows:

BL7916		BL7917	
0.50 pH	1.91 K	50 mV	1.91 K
1.00 pH	4.87 K	100 mV	4.87 K
1.50 pH	10 K	150 mV	10 K
2.00 pH	21 K	200 mV	21 K

LEVEL CONTROL

The pump is supplied with these two terminals short-circuited. A contact coming from a level controller (e.g. **H17871**, **H17873**) can be connected to these terminals. If this contact is closed, the pump works normally. If it opens, the unit will not pump even if the controller commands it.

For example, a level controller can be placed in the tank of the liquid being dosed so that the pump is stopped when the chemicals are exhausted.

MANUAL

An auxiliary switch can be connected to these terminals to force the unit to pump whatever value is measured by the controller. This might be needed for example when the pump needs to be primed.

AUXILIARY CONTACT

The controller can drive a relay when the measure overtakes the setpoint. The contact available on the terminals can be normally open or closed. It can be used as a switch to drive an external mixer when the pump is dosing, or can activate an auxiliary pump or any other device. With **BL7916**, the contact can be selected to remain open when the pH value is within the set limits (the pump is not dosing) and closed when the pump is dosing or viceversa.

By shorting the Common (middle) terminal with the NO or NC terminal on the driving circuit inside the controller section, a normally open or a normally closed state can be achieved, as shown below:

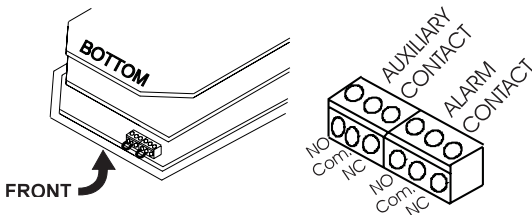

ALARM CONTACT

If the reading drifts from the setpoint by more than ± 2.00 pH in **BL7916** and ± 200 mV in **BL7917**, an external alarm can be activated. The contact is rated at 2 amps at 220VAC. No power is supplied through the system and it is an open/closed contact only.

With **BL7916**, the contact can be selected to be closed when the alarm is activated and open when the alarm is off or viceversa. Short the middle terminal located on the driving circuit inside the controller section with the NO or NC terminal (see above).

4-20 mA ISOLATED OUTPUT

A 4-20 mA proportional output is available in these connections:

$$4 \text{ mA} = 0 \text{ pH}; 20 \text{ mA} = 14 \text{ pH (BL7916)}$$

and

$$4 \text{ mA} = -999 \text{ mV}; 20 \text{ mA} = +999 \text{ mV (BL7917)}.$$

The output is optically isolated.

SETPOINT ADJUSTMENTS

- Move the display selector switch to SET.



- With a small screwdriver adjust the SET COARSE trimmer to display a value close to the desired setpoint e.g. 7.00.



- Adjust the SET FINE trimmer to display the exact setpoint value.



- Once the desired setpoint is achieved, move the display selector switch back to MEASURE.

ACID OR BASE SELECTION (BL7916 only)

If an acid chemical is to be dosed, move the ACID/BASE switch to ACID. This means that the pump will dose when pH measurements are higher than the setpoint.



If an alkaline chemical is to be dosed, move the ACID/BASE switch to BASE. This means that the pump will dose when pH measurements are lower than the setpoint.



REDUCING OR OXIDIZING SELECTION (BL7917 only)

If a reducing chemical is to be dosed, move the RED/OXID switch to RED. This means that the pump will dose when redox measurements are higher than the setpoint.



If an oxidizing chemical is to be dosed, move the RED/OXID switch to OXID. This means that the pump will dose when the redox measurements are lower than the setpoint.



The wires and cables needed for all connections can be fed through the two cable fittings located below the terminals. It is important to attach these cables properly because pump vibrations could loosen them. Replace the transparent cover and fasten the screws.

pH CALIBRATION

BL7916 *only*:

- Ensure that the display selector switch is set to MEASURE and dip the electrode tip in a neutral buffer solution (pH7.01).



- Adjust the OFFSET trimmer to display 7.01 on the LCD.

OFFSET



- Rinse the electrode with clean water and dip the electrode tip in pH4.01 (acidic) or pH10.01 (alkaline) buffer solution.



- Adjust the slope trimmer to read 4.01 or 10.01 on the LCD.

SLOPE



The slope calibration with pH4.01 buffer is suggested if the controller will be used for acid measurements or pH values below 7, pH10.01 is in turn recommended for alkaline measurements or pH values above 7.

TROUBLESHOOTING GUIDE

ELECTRICAL

The pump does not operate when turned ON:

- Check the power supply and connections. Voltage should be between 100 - 130 VAC for 115 V models and between 200 - 250VAC for 230 V models.
- See Installation section on page 11 or call contact your local Hanna Instruments Office for technical assistance.

OPERATING

Display does not indicate:

- Check that the pump is properly plugged in
- Check the fuse.

Display shows 1 on the far left hand side:

- Check electrode and/or electrode cable.



"No Dosage" LED is lit:

- Check the tank where the level controller is working or verify the connection on the terminals (they must be short for the pump to dose).

LIQUID

The pump operates but does not prime:

- Check for a clogged or loose filter on the suction valve assembly. Retighten if necessary.
- Check to see if the pump is too high above the foot valve assembly (HI721005) in the feed tank. This vertical distance should not exceed 1.5 meters (5 feet). Either lower the pump or raise the feed tank.
- Check the pump head, suction and discharge valves for blockage.

Pump flow rate is reduced:

- Check the pump head, discharge and injection valve assembly for any clogging. Clean and reassemble.
- Check for any additional back pressure created since the last flow rate was conducted.
- Check for any changes in the viscosity of the chemical being used.
- Be sure that valves have been properly installed in the pump head.

Leakage at the connections:

- Be sure that the hose is fully seated and hose connectors are tight.
- Be sure that valves are tight and O-rings are in place.

Leakage around the pump head:

- Be sure that the valves are tight and O-rings are in place and the head screws (hex bolts) are tight.

MAINTENANCE

Your BlackStone Pump is designed to give you years of trouble-free service. Maintenance should be the preventative type, that is, periodic cleaning and inspecting for any damage or leakage.

CLEANING THE SUCTION, DISCHARGE AND INJECTION VALVES

Remove the valves from the pump head, the injection fitting and the feed.

Keep the suction and discharge valves separated as they are not interchangeable.

Disassemble each valve and clean it with a neutral liquid. Inspect the PVDF springs. After cleaning the glass balls, inspect them for any excessive wear due to abrasion from the chemical. Replace if necessary with parts from **HI721102**, **HI721105**, **HI721004** and **HI721005** (see page 34 for listing).

When reinstalling the valves into the pump head, tighten by hand first and then with a wrench $\frac{1}{4}$ to $\frac{1}{2}$ turn.

INSPECTING THE HOSE (if used as supplied with the pump)

Inspect to see if the hose has worn out or weakened due to the chemicals. Pay particular attention for any signs of abrasion or discoloration. Also check the connectors to ensure they are tight.

Replace if necessary with parts from **HI720032**.

CLEANING THE PUMP HEAD

The **pump head** should be cleaned at regular intervals and at least once a year. Remove the deposits that form in the cavities with a solution that is neutral to the chemical the pump has been dosing. Inspect the head for any cracks or worn areas.

Replace if necessary with parts from **HI721106 (pump head)**.

SCHEDULED MAINTENANCE

After 50 hours

Tight the **pump head** screws with a torque force of 2.5 Nm (22" lbf).

After 12 months

It is recommended to replace **HI721102**, **HI721103** (suction and discharge valves assemblies) as well as the O-rings. The LDPE hose can also deteriorate over time and, for safety reasons, should also be changed with **HI720032**.

After 24 months

It is recommended to replace **HI721102**, **HI721103**, **HI720032** and **HI721106**.

ELECTRODE CONDITIONING AND MAINTENANCE

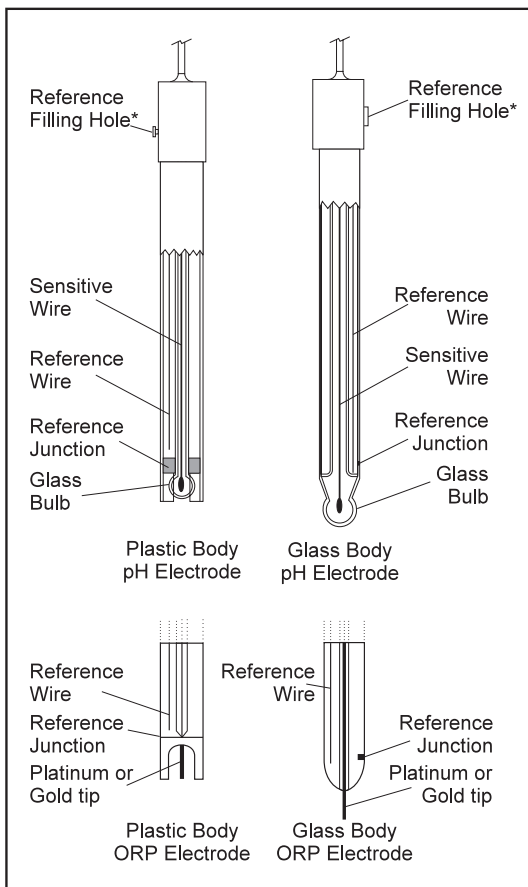

* Only available with refillable electrodes. For industrial applications, gel-filled electrodes are preferable due to lesser maintenance requirements.

PREPARATION

Remove the protective cap.

DO NOT BE ALARMED IF ANY SALT DEPOSITS ARE PRESENT.

This is normal with electrodes and they will disappear when rinsed with water.

During transport tiny bubbles of air may have formed inside the glass bulb. The electrode cannot function properly under these conditions.

These bubbles can be removed by "shaking down" the electrode as you would do with a glass thermometer.

If the bulb and/or junction are dry, soak the electrode in **HI70300** storage solution for at least one hour.

For refillable electrodes:**

If the refill solution (electrolyte) is more than 2½ cm (1") below the fill hole, add **HI7082** 3.5M KCl electrolyte solution for double junction or **HI7071** 3.5M KCl+AgCl electrolyte solution for single junction electrodes.

For AmpHel® electrodes:

If the electrode does not respond to pH changes, the battery is run down and the electrode should be replaced.

TEST MEASUREMENT

Rinse the electrode tip with distilled water.

Immerse the tip (bottom 4 cm / 1½") in the sample and stir gently for approximately 30 seconds.

For a faster response and to avoid cross contamination of the samples, rinse the electrode tip with the solution to be tested, before taking your measurements.

STORAGE

To minimize clogging and assure a quick response time, the glass bulb and the junction should be kept moist and not allowed to dry out. This can be achieved by installing the electrode in such a way that it is constantly in a well filled with the sample (stream or tank).

When not in use, replace the solution in the protective cap with a few drops of **HI70300** storage solution.

Follow the Preparation Procedure above before taking measurements.

NEVER STORE THE ELECTRODE WITH DISTILLED OR DEIONIZED WATER.

PERIODIC MAINTENANCE

Inspect the electrode and the cable. The cable used for the connection to the controller must be intact and there must be no points of broken insulation on the cable or cracks on the electrode stem or bulb.

Connectors must be perfectly clean and dry. If any scratches or cracks are present, replace the electrode. Rinse off any salt deposits with water.

**For industrial applications, gel-filled electrodes are preferable due to lesser maintenance requirements.
AmpHel® is a registered Trademark of "Hanna Instruments"

For refillable electrodes**:

Refill the electrode with fresh electrolyte (**HI7071** for single junction or **HI7082** for double junction electrodes). Allow the electrode to stand upright for 1 hour. Follow the Storage Procedure above.

CLEANING PROCEDURE

General Soak in **HI7061** general cleaning solution for approximately 30 minutes.

Removal of films, dirt or deposits on the membrane/junction:

Protein Soak in **HI7073** protein cleaning solution for 15 minutes.

Inorganic Soak in **HI7074** inorganic cleaning solution for 15 minutes.

Oil/grease Rinse with **HI7077** Oil & Fat cleaning solution.

IMPORTANT: After performing any of the cleaning procedures rinse the electrode thoroughly with distilled water, drain and refill the reference chamber with fresh electrolyte (not necessary for gel-filled electrodes), and soak the electrode in **HI70300** storage solution for at least 1 hour before reinstalling it.

TROUBLESHOOTING

Evaluate your electrode performance based on the following.

- **Noise** (Readings fluctuate up and down) could be due to:
 - **Clogged/Dirty Junction:** Refer to the Cleaning Procedure above.
 - **Loss of shielding** due to low electrolyte level (refillable electrodes only): refill with **HI7071** for single junction or **HI7082** for double junction electrodes.
- **Dry Membrane/Junction:** Soak in **HI70300** storage solution for at least 1 hour. Check to make sure the installation is such as to create a well for the electrode bulb to constantly remain moist.
- **Drifting:** Soak the electrode tip in warm **HI7082** solution for one hour and rinse tip with distilled water (if necessary, refill with fresh **HI7071** for single junction electrodes and **HI7082** for double junction electrodes).
- **Low Slope:** Refer to the cleaning procedure above.
- **No Slope:**
 - Check the electrode for cracks in glass stem or bulb (replace the electrode if cracks are found).
 - Make sure cable and connections are not damaged nor lying in a pool of water or solution.

**For industrial applications, gel-filled electrodes are preferable due to lesser maintenance requirements.

- **Slow Response/Excessive Drift:** Soak the tip in Hanna Instruments Solution **HI7061** for 30 minutes, rinse thoroughly in distilled water and then follow the Cleaning Procedure above.
- **For ORP Electrodes:** polish the metal tip with a lightly abrasive paper (paying attention not to scratch the surface) and wash thoroughly with water.

Note: with industrial applications, it is always recommended to keep at least one spare electrode handy. When anomalies are not resolved with a simple maintenance, change the electrode (and recalibrate the controller) to see if the problem is alleviated.

TAKING REDOX MEASUREMENTS

Redox measurements allow the quantification of the oxidizing or reducing power of a solution, and are commonly expressed in mV.

Oxidation may be defined as the process during which a molecule (or an ion) loses electrons and reduction as the process by which electrons are gained.

Oxidation is always coupled together with reduction so that as one element gets oxidized, the other is automatically reduced, therefore the term oxidation-reduction is frequently used.

Redox potentials are measured by an electrode capable of absorbing or releasing electrons without causing a chemical reaction with the elements with which it comes into contact.

The electrodes most usually available for this purpose have gold or platinum surfaces; gold possesses a higher resistance than platinum in conditions of strong oxidation such as cyanide, while platinum is preferred for the measurements of oxidizing solutions containing halides and for general use.

When a platinum electrode is immersed in an oxidizing solution a monomolecular layer of oxygen is developed on its surface. This layer does not prevent the electrode from functioning, but it increases the response time. The opposite effect is obtained when the platinum surface absorbs hydrogen in the presence of reducing mediums. This phenomenon is rough on the electrode.

To make correct redox measurements the following conditions must prevail:

- The surface of the electrode must be cleaned and smooth.
- The surface of the electrode must undergo a pretreatment in order to respond quickly.

Because the Pt/PtO system depends on the pH, the pretreatment of the electrode may be determined by the pH and the redox potential values of the solution to be measured.

As a general rule, if the ORP mV reading corresponding to the pH value of the solution is higher than the values in the table below, an oxidizing pretreatment is necessary; otherwise a reducing pretreatment is necessary:

pH	mV	pH	mV	pH	mV	pH	mV	pH	mV
0	990	1	920	2	860	3	800	4	740
5	680	6	640	7	580	8	520	9	460
10	400	11	340	12	280	13	220	14	160

Reducing pretreatment: immerse the electrode in **HI7091** solution for a few minutes.

Oxidizing pretreatment: immerse the electrode in **HI7092** solution for a few minutes.

If the pretreatment is not performed, the electrode will take significantly longer to respond.

As with pH electrodes, gel-filled redox electrodes are more suitable for industrial applications due to lesser maintenance requirements. However, if working with refillable electrodes, the electrolyte level should not fall more than 2½ cm (1") below the fill hole and topped up if necessary. Use **HI7071** refill solution for single junction and **HI7082** for double junction electrodes.

In the event that measurements are performed with solutions containing sulfides or proteins, the cleaning of the diaphragm of the reference electrode must be performed more often.

In order to have a correct functioning of the ORP electrode, immerse it into **HI7021** and measure the response; the obtained value should be within 240 ± 20 mV.

After this functional test, it is suggested to wash the electrode thoroughly with water and proceed to the oxidizing or reducing pretreatment before taking measurements.

When not in use, the electrode tip should be kept moist and far from any type of mechanical stress which might cause damage. This can be achieved by installing the electrode in such a way that it is constantly in a well filled with the sample (stream or tank). The protective cap can also be filled with **HI70300** storage solution if the electrode is not being used at all.

Note: With industrial applications, it is always recommended to keep at least one spare electrode handy. When anomalies are not resolved with a simple maintenance, change the electrode to see if the problem is alleviated.

CHEMICAL COMPATIBILITY GUIDE

PARTIAL LISTING OF CHEMICALS THAT CAN BE USED WITH BLACKSTONE PUMPS

(Rated for 45 °C. For higher temperatures consult contact your local Hanna Instruments Office.)

Adipic Acid	Caustic Soda
Alcohol Amyl	Chloral Hydrate
Alcohol, Diacetone	Chromic Acid 50%
Alcohol, Isopropyl	Citric Acid
Alcohol, Methyl	Copper Chloride
Aluminium, Ammonium Sulfate	Copper Cyanide
Aluminium Chloride	Copper Nitrate
Aluminium Sulfate	Copper Sulfate
Alums	Corn Oil
Ammonium Carbonate	Cottonseed Oil
Ammonium Chloride	Cresylic Acid
Ammonium Fluoride	Crude Oil
Ammonium Hydroxide	Dextrose
Ammonium Nitrate	Detergents (general)
Ammonium Phosphate	Diesel Fuel
Ammonium Sulfate	Diethyl Phthalate
Aqua Ammonia	Disodium Phosphate
Arsenic Acid	Ethanol (1-95%)
Barium Carbonate	Ethylene Dichloride
Barium Chloride	Ethylene Glycol
Barium Hydroxide	Fatty Acids
Barium Sulfate	Ferric Chloride
Beer	Ferric Nitrate
Beet Sugar Liquors	Ferric Sulfate
Bismuth Carbonate	Ferrous Chloride
Black Liquor	Ferrous Sulfate
Bleach	Fluoboric Acid
Borax	Fluosilicic Acid
Boric Acid	Formaldehyde
Bromic Acid	Fruit Juice Pulp
Butyric Acid	Fuel Oil
Calcium Bisulfite	Gallic Acid
Calcium Carbonate	Gasoline, Refined
Calcium Chlorate	Glucose
Calcium Chloride	Glycerine or Glycerol
Calcium Hydroxide	Glycolic Acid 30%
Calcium	Hexane
Hypochlorite	Hydrazine
Calcium Nitrate	Hydrobromic Acid 20%
Calcium Sulfate	Hydrochloric Acid (Concentrated)
Carbonic Acid	Hydrochloric Acid (Diluted)
Castor Oil	Hydrofluoric Acid 60%

Hydrogen Sulfide Aqueous Solution	Propyl Alcohol
Hypochlorous Acid	Propylene Dichloride
Kerosene	Sea Water
Lactic Acid	Silver Nitrate
Lard Oil	Silver Plating Solutions
Lauric Acid	Soaps
Lead Acetate	Sodium Acetate
Linoleic Acid	Sodium Bicarbonate
Linseed Oil	Sodium Bisulfate
Lithium Salts	Sodium Bisulfite
Magnesium Carbonate	Sodium Borate
Magnesium Chloride	Sodium Chlorate
Magnesium Hydroxide	Sodium Chloride
Magnesium Nitrate	Sodium Cyanide
Magnesium Oxide	Sodium Fluoride
Magnesium Sulfate	Sodium Hexametaphosphate
Maleic Acid	Sodium Hydroxide 50%
Malic Acid	Sodium Hypochlorite 18%
Mercuric Chloride	Sodium Metaphosphate
Methanol	Sodium Nitrate
Methyl Sulfate	Sodium Peroxide
Milk	Sodium Phosphate
Mineral Oils	Sodium Silicate
Noptha Petroleum	Sodium Sulfate
Nickel Chloride	Sodium Sulfide
Nickel Sulfate	Sodium Sulfite
Nitric Acid 50%	Sodium Thiosulfate
Oils and Fats	Sour Crude Oil
Oleic Acid	Stannic Chloride
Olive Oil	Stannous Chloride
Oxalic Acid	Stearic Acid
Palmitric Acid	Sulfur
Perchloric Acid 70%	Sulfuric Acid Concentration
Perchloroethylene	Sulfurous Acid
Petroleum Oils (sour)	Tannic Acid
Phenol	Tanning Liquors
Phosphoric Acid	Tartaric Acid
Photographic Solutions	Tetrachlorethane
Plating Solutions	Tetraethyl Lead
Potassium Carbonate	Tetralin
Potassium Bromide	Tin Salts
Potassium Chlorate	Vegetable Oils
Potassium Chloride	Vinegar
Potassium Cyanide	Water Acid, Mine
Potassium Ferrocyanide	Water, Fresh
Potassium Hydroxide	Water, Distilled
Potassium Nitrate	Water, Salt
Potassium Permanganate 10%	Whiskey
Potassium Phosphate	Wines
Potassium Sulfate	Zinc Chloride
	Zinc Sulfate

ACCESSORIES

SPARE PARTS

HI721102 Discharge Valve (Glass Ball, Valve O-Ring, Hose Connector)

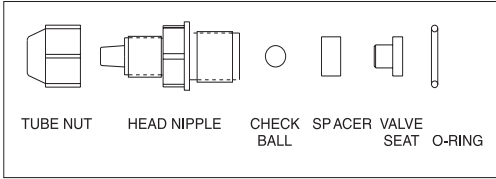

HI721103 Suction Valve (Glass Ball, Valve O-Ring, Hose Connector)

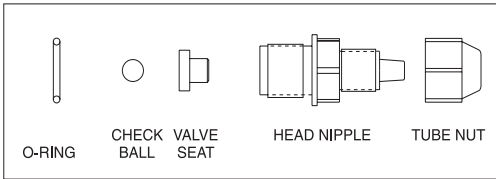

HI721003 10 x Glass Balls and 10 x Valve O-Rings

HI721004 Injection Valve Assembly

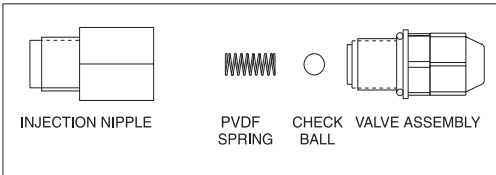

HI721005 Foot Valve Assembly

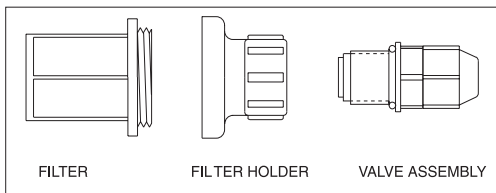

- HI721006 PVDF Springs, 4 pcs
 HI720032 LDPE Hose - 100 m (330')
 HI721008 Ceramic Weights, 4 pcs

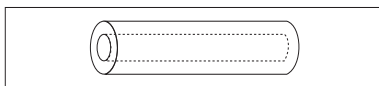

- HI721101 **Pump head**, O-Ring, 6 screws and washers
 HI721106 **Pump head**, Large PTFE Diaphragm, Aluminum Piston and Aluminum Disk

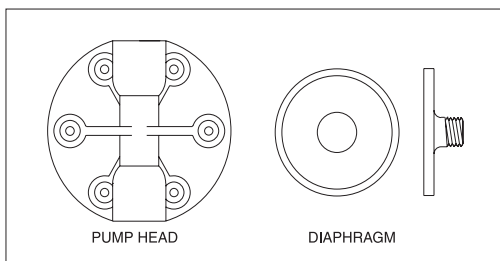

pH CALIBRATION SOLUTIONS

- HI7004M pH4.01 buffer solution, 230 mL bottle
 HI7004L pH4.01 buffer solution, 500 mL bottle
 HI7006M pH6.86 buffer solution, 230 mL bottle
 HI7006L pH6.86 buffer solution, 500 mL bottle
 HI7007M pH7.01 buffer solution, 230 mL bottle
 HI7007L pH7.01 buffer solution, 500 mL bottle
 HI7009M pH9.18 buffer solution, 230 mL bottle
 HI7009L pH9.18 buffer solution, 500 mL bottle
 HI7010M pH10.01 buffer solution, 230 mL bottle
 HI7010L pH10.01 buffer solution, 500 mL bottle

ORP SOLUTIONS

- HI7021M ORP test solution 240 mV, 230 mL bottle
 HI7021L ORP test solution 240 mV, 500 mL bottle
 HI7091M Reducing pretreatment solution, 230 mL
 HI7091L Reducing pretreatment solution, 500 mL
 HI7092M Oxidizing pretreatment solution, 230 mL
 HI7092L Oxidizing pretreatment solution, 500 mL

MAINTENANCE SOLUTIONS

HI70300M	Storage solution, 230 mL botte
HI70300L	Storage solution, 500 mL bottle
HI7061M	General cleaning solution, 230 mL botte
HI7061L	General cleaning solution, 500 mL bottle
HI7073M	Protein cleaning solution, 230 mL botte
HI7073L	Protein cleaning solution, 500 mL bottle
HI7074M	Inorganic cleaning solution, 230 mL botte
HI7074L	Inorganic cleaning solution, 500 mL bottle
HI7077M	Oil & Fat cleaning solution, 230 mL bottle
HI7077L	Oil & Fat cleaning solution, 500 mL bottle
HI7071	3.5M KCl + AgCl electrolyte solution, 4x50 mL, for single junction electrodes
HI7072	1M KNO ₃ electrolyte solution, 4x50 mL
HI7082	3.5M KCl electrolyte solution, 4x50 mL, for double junction electrodes

RECOMMENDED pH ELECTRODES

All electrodes are gel-filled and with ceramic junction unless otherwise indicated.

HI1090T	Screw connector, external PG13.5 thread, double junction, glass-body
HI1110S	Screw connector, single junction, glass-body
HI1130B/3	BNC connector, 3 m (9.9') cable, single junction, glass-body with external thread
HI1110T	Screw connector, external PG13.5 thread, double junction, glass-body with ground glass junction
HI1114S	Screw connector, double junction plastic-body
HI1134B/3	BNC connector, 3 m (9.9') cable, double junction, plastic body with external thread
HI1115S	Screw connector, single junction, refillable with side-arm, glass-body
HI1135B/3	BNC connector, 3 m (9.9') cable, single junction, refillable with side-arm, glass-body
HI1210T	Screw connector, external PG13.5 thread, double junction, plastic body, cloth junction
HI1910B	BNC connector, 1 m (3.3') cable, double junction, plastic body with built-in amplifier and external thread
HI1912B	BNC connector, 1 m (3.3') cable, double junction, plastic body with built-in amplifier and external thread

- HI1912B/5 BNC connector, 5 m (16.5') cable, double junction, plastic body with built-in amplifier and external thread
- HI2114B/5 BNC connector, 5 m (16.5') cable, double junction, plastic body with external thread and cloth junction
- HI2910B/5 BNC connector, 5 m (16.5') cable, double junction, plastic body with built-in amplifier and cloth junction

PLATINUM ORP ELECTRODES

- HI2930B/5 BNC connector, 5 m (16.5') cable, double junction, Pt, plastic body with built-in amplifier, external thread and cloth junction
- HI3110S Screw connector, single junction, Pt, glass-body
- HI3130B/3 BNC connector, 3 m (9.9') cable, Pt, glass-body with external thread
- HI3110T Screw connector, external PG13.5 thread, double junction, Pt, glass-body
- HI3115S Screw connector, single junction, Pt, refillable with side-arm, glass-body
- HI3135B/3 BNC connector, 3 m (9.9') cable, single junction, Pt, refillable with side-arm, glass-body
- HI3210T Screw connector, external PG13.5 thread, double junction, Pt, plastic body
- HI3410S Screw connector, double junction, Pt, plastic body
- HI3430B/3 BNC connector, 3 m (9.9') cable, double junction, Pt, plastic body with external thread
- HI3932B/5 BNC connector, 5 m (16.5') cable, double junction, Pt, plastic body with built-in amplifier and external thread

GOLD ORP ELECTRODES

- HI4110S Screw connector, single junction, Au, glass-body
- HI4130B/3 BNC connector, 3 m (9.9') cable, single junction, Au, glass-body with external thread
- HI4932B/5 BNC connector, 5 m (16.5') cable, double junction, Au, plastic body with built-in amplifier and external thread

OTHER ACCESSORIES

ChecktempC Electronic thermometer (range -50.0 to 150.0 °C)

ChecktempF Electronic thermometer (range -58.0 to 302 °F)

HI8614 pH transmitter

HI8614L pH transmitter with LCD

HI8615 ORP transmitter

HI8615L ORP transmitter with LCD

BL PUMPS Dosing pumps with flow rate from 1.5 to 20 LPH

HI7871 & HI7873 Level controllers

HI6050 & HI6051 Submersible electrode holders

HI6054 & HI6057 Electrode holders for in-line applications

HI778P Screened coaxial cable with screw connectors

HI8427 pH/ORP electrode simulator

HI931001 pH/ORP electrode simulator with LCD

CE DECLARATION OF CONFORMITY



DECLARATION OF CONFORMITY

We

Hanna Instruments Italia Srl
via E.Fermi, 10
35030 Sarmeola di Rubano - PD
ITALY

herewith certify that the dosing pumps and controllers

BL7916 BL7917

have been tested and found to be in compliance with EMC Directive 89/336/EEC and Low Voltage Directive 73/23/EEC according to the following applicable normatives:

EN 50082-1: Electromagnetic Compatibility - Generic Immunity Standard

IEC 801-2 Electrostatic Discharge

IEC 801-3 RF Radiated

IEC 801-4 Fast Transient

EN 50081-1: Electromagnetic Compatibility - Generic Emission Standard

EN 55011 Radiated, Class B

EN61010-1: Safety requirements for electrical equipment for measurement, control and laboratory use

Date of Issue: 1-12-1998

P. Cesa - Technical Director

On behalf of
Hanna Instruments S.r.l.

Recommendations for Users

Before using these products, make sure that they are entirely suitable for the environment in which they are used.

Operation of these instruments in residential areas could cause unacceptable interference to radio and TV equipment.

Any variation introduced by the user to the supplied equipment may degrade the instruments' EMC performance.

Unplug the instruments from power supply before replacing the fuse or making any electrical connections.

Hanna Instruments reserves the right to modify the design, construction and appearance of its products without advance notice.

SALES AND TECHNICAL SERVICE CONTACTS

Australia:

Tel. (03) 9769.0666 • Fax (03) 9769.0699

China:

Tel. (10) 88570068 • Fax (10) 88570060

Egypt:

Tel. & Fax (02) 2758.683

Germany:

Tel. (07851) 9129-0 • Fax (07851) 9129-99

Greece:

Tel. (210) 823.5192 • Fax (210) 884.0210

Indonesia:

Tel. (21) 4584.2941 • Fax (21) 4584.2942

Japan:

Tel. (03) 3258.9565 • Fax (03) 3258.9567

Korea:

Tel. (02) 2278.5147 • Fax (02) 2264.1729

Malaysia:

Tel. (603) 5638.9940 • Fax (603) 5638.9829

Singapore:

Tel. 6296.7118 • Fax 6291.6906

South Africa:

Tel. (011) 615.6076 • Fax (011) 615.8582

Taiwan:

Tel. 886.2.2739.3014 • Fax 886.2.2739.2983

Thailand:

Tel. (662) 619.0708.11 • Fax (662) 619.0061

United Kingdom:

Tel. (01525) 850.855 • Fax (01525) 853.668

USA:

Tel. (401) 765.7500 • Fax (401) 765.7575

MAN7916
10/17

For e-mail contacts and complete list of Sales and Technical offices, please see www.hannainst.com